

# LINETRAXX® RCMA423

Residual current monitor for monitoring AC-, DC- and pulsed DC currents in TN- and TT systems



# LINETRAXX® RCMA423

Residual current monitor for monitoring AC-, DC- and pulsed DC currents in TN- and TT systems



LINETRAXX® RCMA423

## Device features

- AC/DC sensitive residual current monitor Type B acc. to IEC 62020 and IEC/TR 60755
- r.m.s. value measurement (AC+DC)
- Two separately adjustable response values 30...3 A
- Frequency range 0...2000 Hz
- Start-up delay, response delay and delay on release
- Digital measured value display via LC display
- Measured value memory for operating value
- CT connection monitoring
- LEDs: Power On, Alarm 1, Alarm 2
- Internal/external test/reset button
- Two separate alarm relays (one changeover contact each)
- N/O or N/C operation and fault memory selectable
- Continuous self monitoring
- Multi-functional LC display
- Password protection for device settings
- Sealable transparent cover
- Push-wire terminal (two terminals per connection)
- Two-module enclosure (36 mm)

## Approvals



## Product description

The AC/DC sensitive residual current monitor RCMA423 is designed for monitoring earthed power supply systems (TN and TT systems) where smooth DC fault currents or residual currents continuously greater than zero may occur. These are in particular loads containing six-pulse rectifiers or one way rectifiers with smoothing, such as converters, battery chargers, construction site equipment with frequency-controlled drives. Currents in single conductors can also be monitored by RCMA423.

The prewarning stage (50...100 % of the set response value  $I_{\Delta n2}$ ) allow to distinguish between prewarning and alarm. Since the values are measured with measuring current transformers, the device is nearly independent of the load current and the nominal voltage of the system.

## Applications

- AC/DC sensitive residual current monitoring in earthed two, three or four conductor systems (TN and TT systems)
- Monitoring of variable-speed drives, UPS systems, construction site equipment, printing machines, battery systems, laboratory equipment, wood working machines, MF welding systems, furniture industry, medical electrical equipment, etc.
- AC/DC sensitive current monitoring of, in the normal case, de-energised single conductors (e.g. N conductors)

## Function

Once the supply voltage  $U_S$  is applied, the start-up delay is activated. Measured values changing during this time do not influence the switching state of the alarm relays.

Residual current measurement takes place via an external measuring current transformer of the CTUB100 series. The currently measured value is shown on the LC display. In this way any changes, for example when circuits are connected to the system, can be recognised easily. If the measured value exceeds the set response values, the response delays  $t_{on1/2}$  begin. Once the response delay  $t_{on1/2}$  has elapsed, the K1/K2 alarm relays switch and the alarm LEDs AL1/AL2 light up. If the current falls below the release value (response value plus hysteresis), the release delay  $t_{off}$ . When  $t_{off}$  has elapsed, the alarm relays return to their initial position and the alarm LEDs AL1/AL2 go out. If the fault memory is activated, the alarm relays remain in the alarm state and the LEDs light until the reset button is pressed or until the supply voltage is interrupted. The device function can be tested using the test button. Parameters are assigned to the device via the LCD and the control buttons on the front panel; this function can be password-protected.

## Connection monitoring

The function of the device and the CT connections are continuously monitored. In the event of a fault, the alarm relays K1/K2 switch without delay, the alarm LEDs AL1/AL2/ON flash. On removal of the fault, the alarm relays return to their initial position either automatically or by pressing the reset button.



Operating and display elements

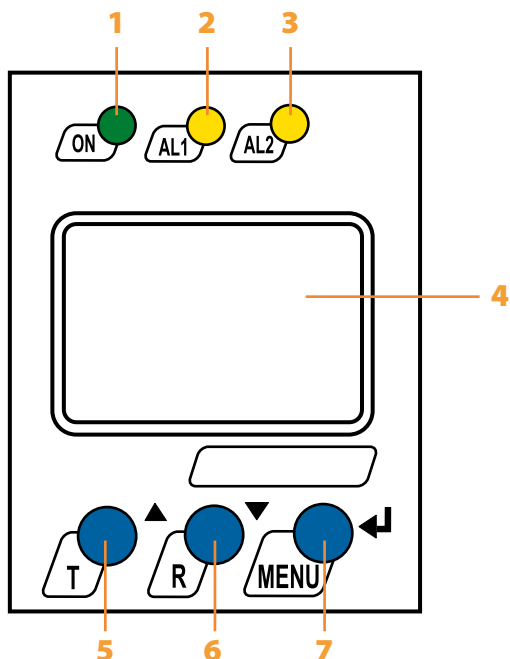

- 1 - Power On LED "ON" (green); lights when supply voltage is applied and flashes in the event of system fault alarm respectively in the event of CT malfunction.
- 2 - Alarm LED "AL1" (yellow), prewarning; lights when the set response value  $I_{\Delta n1}$  is exceeded or flashes in the event of system fault alarm respectively in the event of CT malfunction
- 3 - Alarm LED "AL2" (yellow), alarm; lights when the set response value  $I_{\Delta n2}$  is exceeded or flashes in the event of system fault alarm respectively in the event of CT malfunction
- 4 - Multi-functional LC display
- 5 - Test button "T": to call up the self test.  
Arrow up button: parameter change, to move up in the menu
- 6 - Reset button "R": to delete saved alarms.  
Arrow down button: parameter change, to move down in the menu
- 7 - "MENU" button: to call up the menu system.  
Enter button: to confirm parameter change.  
"ESC" button: press the button > 1.5 seconds.

Wiring diagram

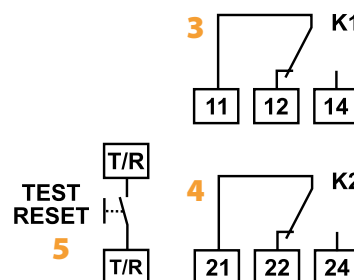
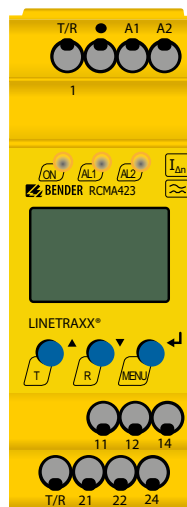
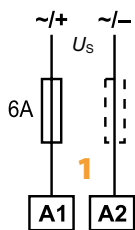
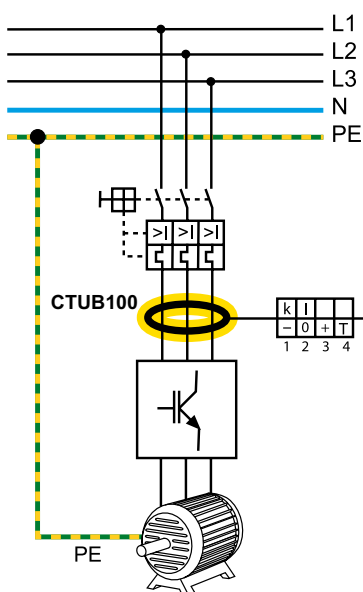

- 1 - **A1, A2** Supply voltage  $U_s$  see ordering information, 6 A fuse recommended
- 2 - Connector for the external CTUB100 series measuring current transformer
- 3 - **11, 12, 14** Alarm relay "K1":  $I_{\Delta n1}$  (prewarning)
- 4 - **21, 22, 24** Alarm relay "K2": alarm  $I_{\Delta n2}$  (alarm)

- 5 - **T/R** Combined test and reset button "T/R"  
short-time pressing (< 1.5 s) = RESET  
long-time pressing (> 1.5 s) = TEST

**Do not route the PE conductor through the measuring current transformer!**

### Connection of measuring current transformers

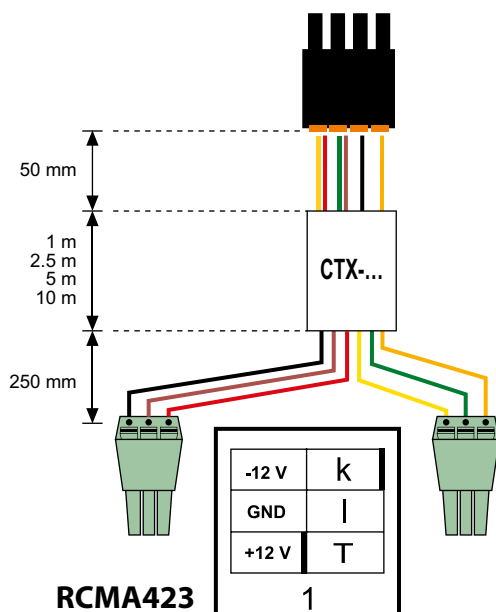
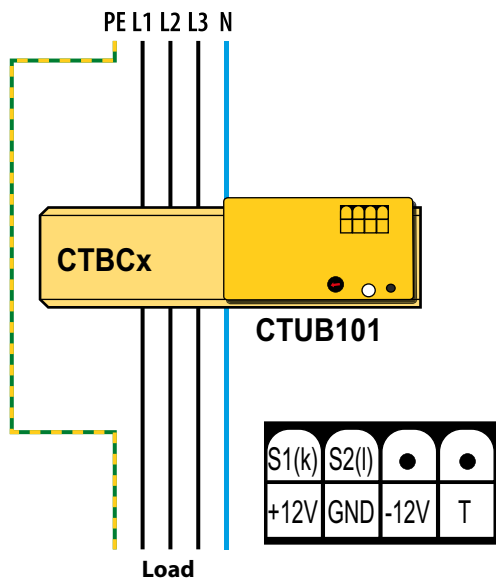

Connection to the RCMA423 residual current monitor using the CTX... connecting cable.

Colour coding for CTX...: k = yellow, l = green, -12 V = black, GND = brown, +12 V = red, Test (T) = orange

### Dimension diagram XM420

Dimensions in mm

Open the front plate cover in direction of arrow!

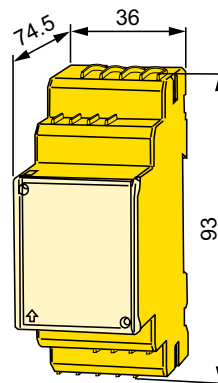

### Screw mounting

Note: The upper mounting clip must be ordered separately (see ordering information).

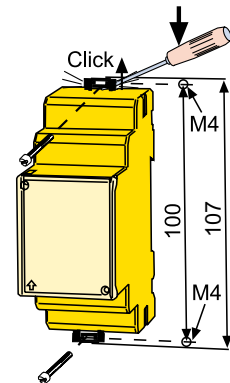

### Residual operating current ranges of the different measuring current transformers

Residual operating current ranges	Type
10...500 mA	CTUB10x-CTBC20(P)
30 mA...10 A	CTUB10x-CTBC35(P), CTUB10x-CTUBC60(P)
100 mA...10 A	CTUB10x-CTBC120P, CTUB10x-CTBC210P
300 mA...10 A	CTUB10x-CTBC120, CTUB10x-CTBC210

**Technical data**
**Insulation coordination acc. to IEC 60664-1/IEC 60664-3**

<b>RCMA423-D-1:</b>	
Rated insulation voltage	100 V
Overvoltage category/pollution degree	III/3
Rated impulse voltage	2.5 kV
<b>RCMA423-D-2:</b>	
Rated insulation voltage	250 V
Overvoltage category/pollution degree	III/3
Rated impulse voltage/pollution degree	4 kV

**Supply voltage**

<b>RCMA423-D-1:</b>	
Supply voltage range $U_S$	AC 24...60 V/DC 24...78 V
Operating range $U_S$	AC 16...72 V/DC 9.6...94 V
Frequency range $U_S$	DC, 42...460 Hz
<b>RCMA423-D-2:</b>	
Supply voltage range $U_S$	AC/DC 100...250 V
Operating range $U_S$	AC/DC 70...300 V
Frequency range $U_S$	42...460 Hz

Protective separation (reinforced insulation) between  
(A1, A2) -(k/I, T/R) -(11, 12, 14) -(21, 22, 24)

Voltage test according to IEC 61010-1	2.21 kV
Power consumption	≤ 6.5 VA

**Measuring circuit**

External measuring current transformer	CTUB100 series
Rated insulation voltage (measuring current transformer)	800 V
Rated frequency	0...2000 Hz
Relative uncertainty for $f$	
≤ 2 Hz	0...-35 %
> 2...<16 Hz	-35...+100 %
≥ 16...≤ 1000 Hz	0...-35 %
> 1000...≤ 2000 Hz	± 35 %
Operating uncertainty	0...35 %

**Response values**

Rated residual operating current $I_{\Delta n1}$ (prewarning, AL1)	50...100 % of $I_{\Delta n2}$ (50 %)*
Rated residual operating current $I_{\Delta n2}$ (alarm, AL2)	30 mA...3 A (30 mA)*
Hysteresis	10...25 % (15%)*

**Specified time**

Start-up delay $t$	0...10 s (0.5 s)*
Response delay $t_{on1}$ (prewarning)	0...10 s (1 s)*
Response delay $t_{on2}$ (alarm)	0...10 s (0 s)*
Delay on release $t_{off}$	0...99 s (1 s)*
Operating time $t_{ae}$ bei $I_{\Delta n} = 1 \times I_{\Delta n1/2}$	≤ 180 ms
Operating time $t_{ae}$ bei $I_{\Delta n} = 5 \times I_{\Delta n1/2}$	≤ 30 ms
Response time $t_{an}$	$t_{an} = t_{ae} + t_{on1/2}$
Recovery time $t_b$	≤ 300 ms

**Displays, memory**

Display range, measured value AC/DC	0...6 A
Error of indication	±17.5 %/±2 digit
Measured-value memory for alarm value	data record measured values
Password	off/0...999 (off)*
Fault memory alarm relay	on/off (on)*

**Inputs/outputs**

Cable length for external test/reset button	0...10 m
---	----------

**Cable lengths for measuring current transformers**

Connection CTX...	1 m/2.5 m/5 m/10 m
or alternatively: single wire 6 x 0.75 mm <sup>2</sup>	0...10 m

**Switching elements**

Number of switching elements	2 x 1 changeover contact
Operating principle	N/C operation/N/O operation (N/C operation)*
Electrical endurance, number of cycles	10,000

**Contact data acc. to IEC 60947-5-1**

Utilisation category	AC-13	AC-14	DC-12	DC-12	DC-12
Rated operational voltage	230 V	230 V	24 V	110 V	220 V
Rated operational voltage UL	200 V	200 V	24 V	110 V	200 V
Rated operational current	5 A	3 A	1 A	0.2 A	0.1 A
Minimum contact rating	1 mA at AC/DC ≥ 10 V				

**Environment/EMC**

EMC	EN 61326-1
-----	------------

**Ambient temperatures:**

Operating temperature	-25...+55 °C
Transport	-25...+70 °C
Long-term storage	-25...+55 °C

**Classification of climatic conditions acc. to IEC 60721:**

Stationary use (IEC 60721-3-3)	3K5 (no condensation, no formation of ice)
Transport (IEC 60721-3-2)	2K3
Long-term storage (IEC 60721-3-1)	1K4

**Classification of mechanical conditions acc. to IEC 60721:**

Stationary use (IEC 60721-3-3)	3M4
Transport (IEC 60721-3-2)	2M2
Long-term storage (IEC 60721-3-1)	1M3

**Connection**
**For UL application**

use 60/70°C copper conductors only

Connection type	screw-type terminal or push-wire terminal
-----------------	---

**Screw-type terminal**

Connection properties:	
rigid/flexible/AWG	0.2...4/0.2...2.5 mm <sup>2</sup> /AWG 24...12
Two conductors with the same cross section:	
rigid/flexible	0.2...1.5/0.2...1.5 mm <sup>2</sup>
Stripping length	8 mm
Tightening torque, terminal screws	0.5...0.6 Nm

**Push-wire terminals**

Connection properties:	
rigid	0.2...2.5 mm <sup>2</sup> (AWG 24...14)
flexible without ferrules	0.75...2.5 mm <sup>2</sup> (AWG 19...14)
flexible with ferrules	0.2...1.5 mm <sup>2</sup> (AWG 24...16)
Stripping length	10 mm
Opening force	50 N
Test opening, diameter	2.1 mm

**Other**

Operating mode	continuous operation
Position of normal use	display-oriented
Degree of protection, internal components (IEC 60529)	IP30
Degree of protection, terminals (IEC 60529)	IP20
Enclosure material	polycarbonate
Flammability class	UL94V-0
DIN rail mounting acc. to	IEC 60715
Screw mounting	2 x M4 with mounting clip
Documentation number	D00063
Weight	≤ 150 g

( )\* = factory setting

## Ordering information

Supply voltage <sup>1)</sup> U <sub>S</sub>		Type	Art. No.	
AC	DC		Screw-type terminal	Push-wire terminal
16...72 V, 42...460 Hz	9,6...94 V	RCMA423-D-1	B94043023	B74043023
70...300 V, 42...460 Hz	70...300 V	RCMA423-D-2	B94043025	B74043025

<sup>1)</sup> Absolute values

## Accessories

Description	Art. No.
Mounting clip for screw mounting (1 piece per device)	B98060008

## Suitable system components

Description	Internal diameter (mm)	Type	Art. No.	Description	Length/m	Type	Art. No.
Measuring current transformers CTUB100 series	ø 20	CTUB101-CTBC20	B78120010	Connection cable measuring current transformer CTUB100 serie	1	CTX-100	B98110080
		CTUB101-CTBC20P	B78120020		2,5	CTX-250	B98110081
	ø 35	CTUB101-CTBC35	B78120012		5	CTX-500	B98110082
		CTUB101-CTBC35P	B78120022		10	CTX-1000	B98110083
	ø 60	CTUB101-CTBC60	B78120014				
		CTUB101-CTBC60P	B78120024				
	ø 120	CTUB101-CTBC120	B78120016				
		CTUB101-CTBC120P	B78120026				
	ø 210	CTUB101-CTBC210	B78120018				
		CTUB101-CTBC210P	B78120028				



### Bender GmbH & Co. KG

P.O. Box 1161 • 35301 Grünberg • Germany  
 Londorfer Strasse 65 • 35305 Grünberg • Germany  
 Tel.: +49 6401 807-0 • Fax: +49 6401 807-259  
 E-Mail: info@bender.de • www.bender.de



BENDER Group